

Kensington®

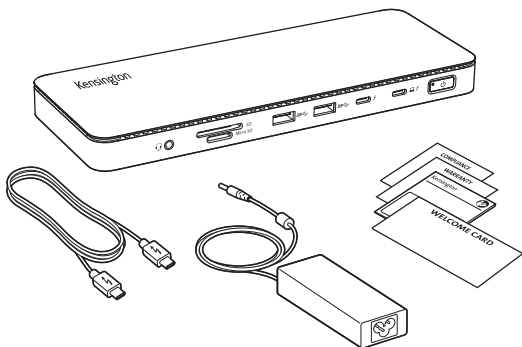

SD5765T Thunderbolt™ 4 Dual 4K Docking Station (DFS)



US



EU



UK



AU/CN



JP



[kensington.com/register](https://www.kensington.com/register)

1

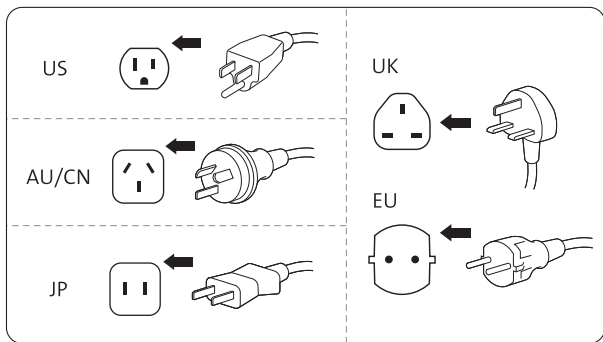
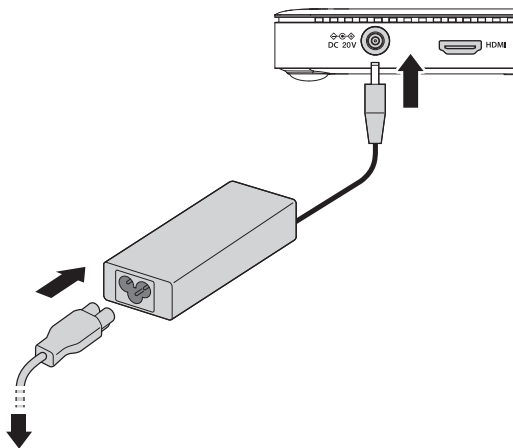

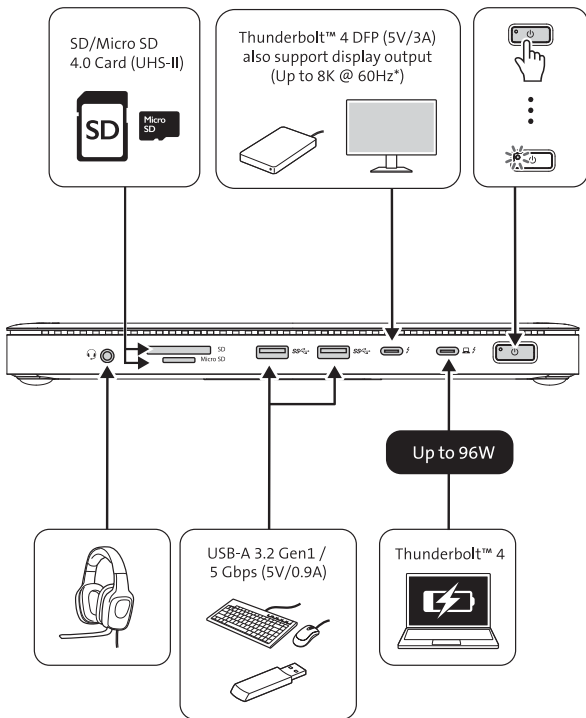

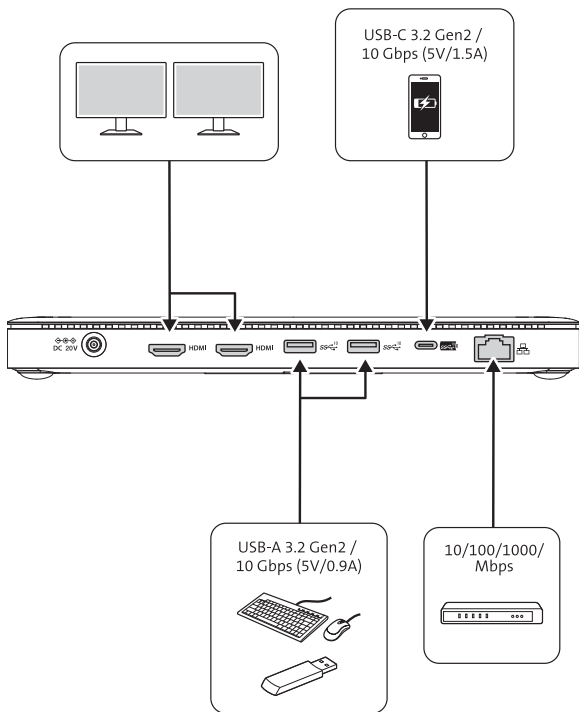



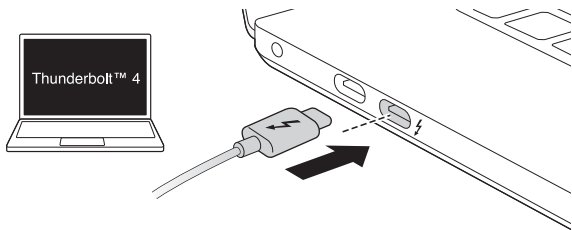



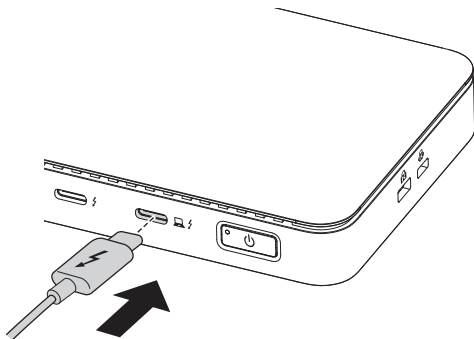

3









4



5

				
		 HDMI	 HDMI	 HDMI
Thunderbolt™ 4 Surface Pro 9-Intel® Surface Pro 8 Surface Laptop 5 Surface Laptop Studio	8K @ 60Hz*	4K @ 60Hz	4K @ 60Hz	

				
		 HDMI	 HDMI	 HDMI
Thunderbolt™ 4 Surface Pro 9-Intel® Surface Pro 8 Surface Laptop 5 Surface Laptop Studio	4K up to 120Hz* or 1080p up to 240Hz	1080p up to 240Hz	1080p up to 240Hz	

* Support for Display Stream Compression (DSC) is based on the host device and monitor capabilities.

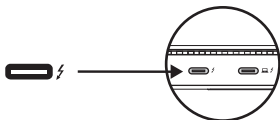

6

Initial Thunderbolt™ 4 connection for Windows

New Thunderbolt™ device have been attached

Thunderbolt™ devices were attached. In order to approve them for use this application must be run with administrator privileges.
Click OK to run the **Thunderbolt™** software with administrator privileges.

OK

Cancel

6.1 Manage Thunderbolt™ 4 devices and settings later



6.2

View Attached Devices

Approve Attached Devices >

Manage Approved Device

Settings

Exit



Sold separately

1

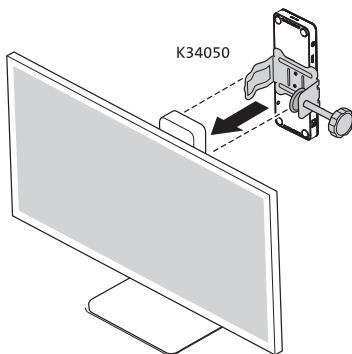

2

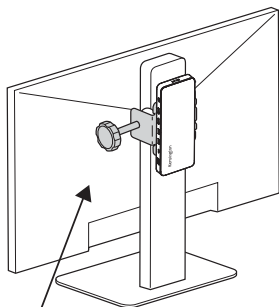

<= 13.2lbs
(<= 6.0kg)

Sold separately

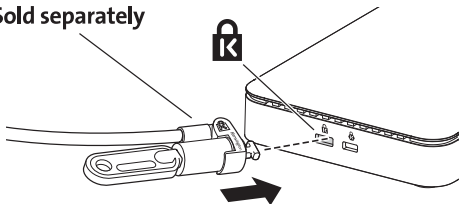

Recommended
K65020WW MicroSaver® 2.0 Keyed Lock

Sold separately

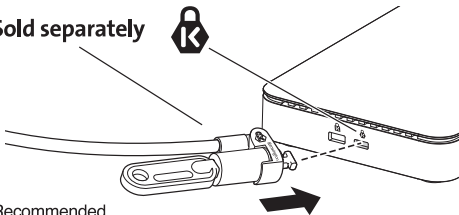

Recommended
K65021WW NanoSaver™ Keyed Laptop Lock

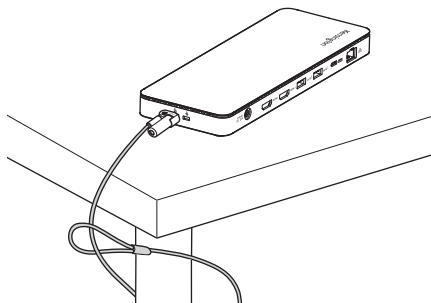



www.kensington.com/support

Kensington® is a registered trademark of ACCO Brands. All other registered and unregistered trademarks are the property of their respective owners.

© 2023 Kensington Computer Products Group, a division of ACCO Brands.

Patents: <https://www.accobrand.com/patents/>

©/TM/® 2023 Microsoft. Microsoft, the Microsoft logo, Microsoft Surface, Surface, and the Microsoft Surface logo are trademarks of the Microsoft group of companies. All other trademarks are the property of their respective owners.

この装置は、クラスB機器です。この装置は、住宅環境で使用することを目的としていますが、この装置がラジオやテレビの受信機に近接して使用されると、受信障害を引き起こすことがあります。

取扱説明書に従って正しい取扱いをして下さい。

VCCI - B

